



SEELLEVEL II™ Tank Monitor

**Model 709-4P
Shop Manual**

IMPORTANT OPERATOR INFORMATION

DATE INSTALLED: _____

SERIAL NUMBER: _____

	Signal Level	Sender Height
Black Water Tank		
Grey Water Tank		
Fresh Water Tank		



SEELVEL II™ Tank Monitor

Model 709-4P

Shop Manual

TABLE OF CONTENTS

- 1) **OVERVIEW**
- 2) **SYSTEM DESCRIPTION**
- 3) **OPERATING INSTRUCTIONS**
- 4) **DISPLAY CALIBRATION**
- 5) **SENDER PROGRAMMING**
- 6) **INSTALLATION GUIDE**
- 7) **TROUBLESHOOTING GUIDE**
- 8) **SERVICE AND WARRANTY INFORMATION**
- 9) **SPECIFICATIONS**

CHAPTER 1 OVERVIEW

The SeeLevel II Tank Monitor represents a massive leap forward in level measurement technology for the Recreational Vehicle industry. The SeeLevel has a combination of features, accuracy, reliability, and diagnostic capability that have never been available before.

The SeeLevel II will monitor the battery voltage and the water and sewer holding tanks. The information is displayed on a 3 digit alpha-numeric LED display. In addition, the system can display the operating characteristics of each of the tank sending units, giving it unsurpassed diagnostic capability.

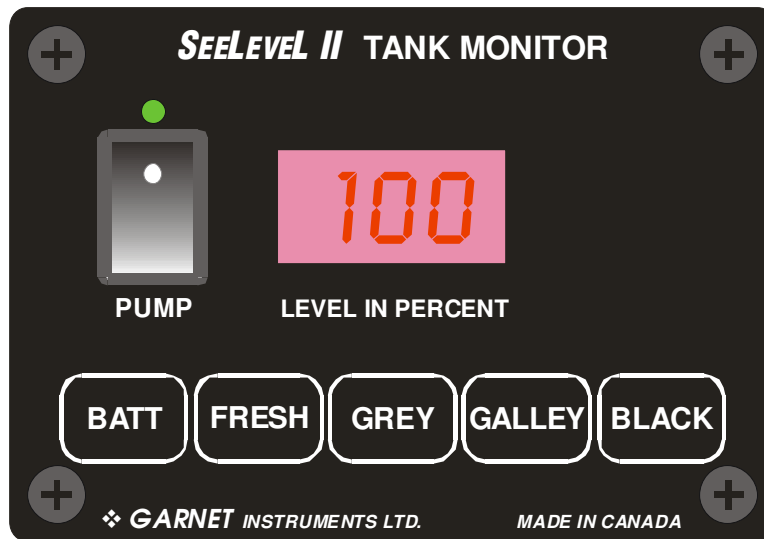

CHAPTER 2 SYSTEM DESCRIPTION

The SeeLevel consists of a display unit that mounts inside the RV, and sender panels that stick to the side of the holding tank. A single two conductor wire is used to connect all the sender panels to the display.

The Sender: Each sender panel is a flexible self adhesive printed circuit board which is stuck to the side of the holding tank. The sender panel can be cut to length to match the height of the tank, and it auto calibrates itself so that it can read from Empty to Full regardless of the height of the tank. The sender scans the water level through the tank wall using patented digital techniques programmed into the sender microprocessor. When the sender transmits the water level information to the display, it sends a digital code that has built in error detection, making it impossible for the display to read an incorrect level, even if the wiring is bad. In addition to the level, the sender also transmits diagnostic information about its operation. This information can be used to determine if there is buildup of sludge on the inside of the tank, or to determine if the sender is delaminating from the side of the tank. If sludge buildup in the tank becomes extreme the gauge will cease to operate (the tank will always read empty), so by monitoring the signal level the tank can be cleaned before the buildup gets excessive. If the fresh or black tanks are more than 12 inches tall, two senders can be stacked to allow measurement of levels up to 24 inches.

The Display: The display receives the information from the three sender panels via a single two conductor wire, and displays the level information in percent of full on a three digit LED display. When the front panel button for a particular tank is pressed, the display powers up and displays the level for that tank. If the button is pressed and released, the display will show the level for about 5 seconds and then shut down automatically. If another button is pressed before the display shuts down, then the new level will immediately be shown. If the same button is pressed twice, the display will hold on that tank and continue to show updated levels for 5 minutes before shutting off. This allows the user to monitor the filling or draining of a tank. By pressing two buttons at once, the diagnostic functions can be accessed, these are described in detail in the troubleshooting chapter.

If a sender is operating properly and connected to the display with good wiring, then the display will show the level normally. If the wiring is disconnected, shorted, or cut, or if the sender panel is defective, then the display will indicate an error code. The various error codes are shown in the troubleshooting chapter.

With these diagnostic features and the digital nature of the tank level sensing technology, it is almost impossible for the system to indicate an incorrect water level, and in the very unlikely event it does occur, the user can verify what is happening with the diagnostic information.

The system also shows the RV battery voltage by measuring the voltage which powers the display. The voltage is shown with a resolution of 0.1 volt.

CHAPTER 3 OPERATING INSTRUCTIONS

The display is the only system component that is accessed by the user. All user input to the display is done using the five buttons along the bottom of the display. Operation of the display is as follows:

To read a water or sewer tank level:

1. Press the button corresponding to the tank to be checked and release it, the display will show the level in percent on the LED display. If no other button is pressed, then the display shut off after about 5 seconds.
2. If another button (including BATT) is pressed before the 5 second time is up for the first button, the display will immediately switch to showing the new level or voltage. The 5 second timeout is restarted every time a button is pressed.
3. To continuously display a reading, press and release the desired button, and then press the same button a second time. When the button is released, the display will be in hold mode, which is indicated by the decimal point on the right hand side turning on. While the display is in the hold mode it will recheck the level once per second so the user can watch the level change while the tank is being filled or drained. The display will automatically shut off after 5 minutes in hold mode. To end the hold mode before the 5 minutes is up, press any tank button, and the display will shut off.

To read the battery voltage:

1. Press the BATT button and release it, the display will show the battery voltage on the LED display.
2. If no other button is pressed, then the display will shut down after about 5 seconds. If the BATTERY button is held down, the display will continuously recheck the voltage and show the updated value. The reading may flicker back and forth between two values, for example, 12.6 and 12.7 volts. This is normal behavior for a digital voltage display.
3. If another button is pressed before the 5 second time is up for the BATTERY button, the display will immediately switch to showing the value for the new button. The 5 second timeout is restarted every time a button is pressed.
4. There is no hold mode for the battery voltage.

CHAPTER 4 DISPLAY CALIBRATION

To program the LED brightness:

1. If the display is to be used inside the coach, the LED brightness should be low. If it is to be used in the service bay area where sunlight can reach it, the LED brightness should be high.
2. To program the LED brightness, the display needs to enter the brightness programming mode. To do this, press and hold down the BATT button, the display will show the battery voltage.
3. While continuing to hold down the BATT button, press and hold down the GREY button. Continue to hold down both buttons for about 5 seconds until the display shows "bri" to indicate the brightness programming mode. When this occurs release both buttons.
4. The display will now indicate the brightness that is currently programmed by showing "b-1", "b-2", "b-3", or "b-4", where "b-1" is the minimum brightness and "b-4" is the maximum brightness.
5. Press the GREY tank button to increase brightness, or the FRESH tank button to decrease brightness.
6. When the display shows the correct brightness, press the BATT button to exit the programming mode.

To program the number of senders for each tank:

1. The fresh and black tanks can have one or two senders, so this information must be programmed into the display. The grey and galley tanks can only have one sender each, so no programming is possible for the number of senders.
2. To program the number of senders for each tank, the display needs to enter the sender programming mode. This should only be done at the time of installation, there is no reason to change the number of senders afterward. Make sure that the number of senders programmed into the display matches with the number of senders connected, otherwise the display will show an error.
3. To enter the sender programming mode, press and hold down the button for the tank to be programmed, the display may show a level or an error message for that tank.
4. While continuing to hold down the button for the tank, press and hold down the BATT button. The display will immediately show "dIA" (diagnostics), continue to hold down both buttons until the display enters the programming mode, this should take about 5 seconds.
5. When the programming mode is entered, the display will show "FrS" if doing the number of senders for the fresh tank or "bLS" if doing the black tank. When this occurs release both buttons.
6. The display will now show "1SE" (one sender) or "2SE" (two senders), based on what is currently programmed into the display. These are the only two options, the display will not work with more than two senders per tank.
7. To change the number of senders, press the tank button, each time the button is pressed the display will switch to the other number.
8. When the display shows the correct number of senders, press the BATT button to exit the programming mode. Both the fresh and black tanks will need to be calibrated individually using this procedure.

The battery voltage is calibrated at the factory, this should never need to be changed.

CHAPTER 5 SENDER PROGRAMMING

To program the sender for the correct tank:

1. Since the senders are all connected in parallel to save wiring and to simplify installation, the senders must be programmed so they know which tank they are on. The senders can be programmed for either the fresh, grey, galley, or black tank. This is done with the three tabs on the top of the sender. See the following diagram.
2. The senders default to fresh tank operation if the programming is not altered. Consequently, if the sender is for the fresh tank, nothing further needs to be done to it.
3. If the sender is for the grey tank, remove the tab that says "**GRY**" next to it.
4. If the sender is for the galley tank, remove the tab that says "**GRY**" next to it, and the tab that says "**TOP**". Even though this would normally be a grey top sender, the display interprets this as the galley sender.
5. If the sender is for the black tank, remove the tab that says "**BLK**" next to it.
6. This is all that is required to program the senders for the correct tank. However, if you make an error, you have one chance to correct it, as described below.
7. If the "**GRY**" tab has been removed and it should be a black tank sender, or if the "**BLK**" tab has been removed and it should be a grey tank sender, then cut out the recessed grey-black correction tab that says "**GBC**" next to it. This reverses the effect of the grey and black tabs.
8. If either the "**GRY**" or "**BLK**" tabs have been removed and it should be for a fresh tank, then remove the other "**GRY**" or "**BLK**" tab. When both the "**GRY**" and "**BLK**" tabs are removed, it is equivalent to neither of them being removed.
9. If the sender is single, no further programming is required.
10. If dual stacked senders are used, the top sender must have additional programming, as described below.

To program the sender as top or bottom:

1. The fresh and black tanks can have stacked senders for tall tanks. The grey and galley tanks can only have single senders, so this section does not apply to them.
2. Since the senders are all connected in parallel to save wiring and to simplify installation, the senders must be programmed so they know whether they are a single, top, or bottom sender. This is done with the tab at the top center of the sender. See the following diagram.
3. The senders default to single or bottom operation if the programming is not altered. Consequently, if the sender is for single or bottom operation, nothing further needs to be done to it (beyond programming it for the correct tank).
4. For a top sender, remove the tab that says "**TOP**" next to it.
5. This is all that is required to program the senders for single, top, or bottom use. However, if you make an error, you have one chance to correct it, as described below.
6. If the "**TOP**" tab has been removed and it should be a single or bottom sender, then cut out the recessed top correction tab that says "**TC**" next to it. This reverses the effect of the top tab.
7. Verify that both the top and bottom senders have been programmed for the correct tank.

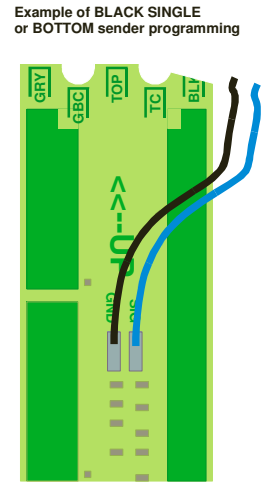
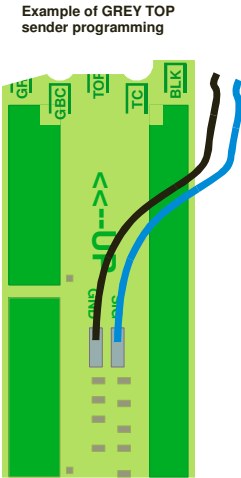
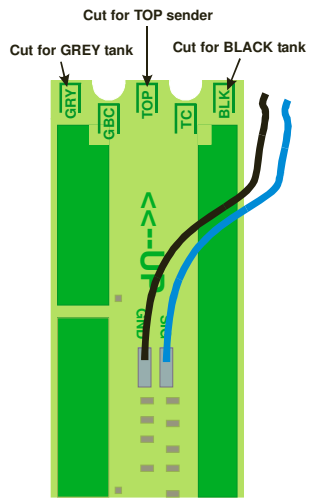

Example of corrected FRESH TOP sender programming (GRY or BLK cut by mistake)

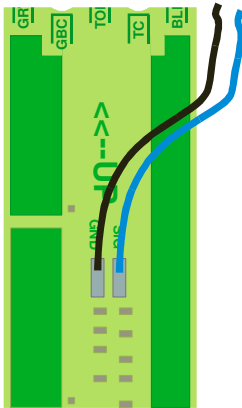

Example of corrected GREY SINGLE or BOTTOM sender programming (BLK cut by mistake)

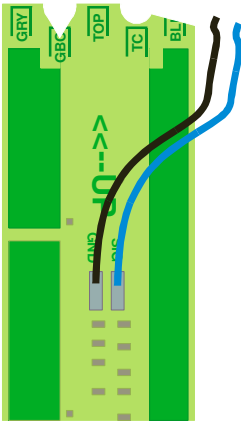

Example of corrected FRESH SINGLE or BOTTOM sender programming (TOP cut by mistake)

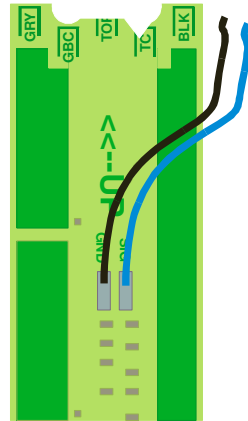

**CHAPTER 6
INSTALLATION GUIDE
(NEW OEM INSTALLATIONS ONLY)**

1. The installation consists of mounting the display inside the RV, cutting and fastening the senders to the sides of the holding tanks, connecting wiring, and programming the display.
2. Mount the display by cutting a hole in the wall 3" wide by 1 7/8" high and bringing the wiring out through the hole to connect to the display panel connector.
3. Connect the wiring according to the following table. It is easier to connect the wiring to the display connector first, and then plug the connector into the display panel. The sender needs to be grounded to a single ground wire from the display.

Wire Color	Function
Red 18 gauge	+12V power input to monitor
Black 18 gauge	Ground
Blue 18 gauge	Tank senders
Yellow 18 gauge	Pump power output

4. Determine where to mount the senders on the tanks. They will need to have a flat area on the side of the tank large enough so the whole width of the sender is in contact with the side of the tank, all the way from the top to the bottom of the tank. Make sure that any metal is at least an inch away from the sender. Clean the area well so that there is no dust, grease, oil, water, etc., that would prevent the adhesive on the sender from sticking.
5. Measure the height of the tank to determine how long the senders should be. For tanks less than 13" tall, follow step 6. For tanks greater than 13" tall, follow step 7.
6. For tanks less than 13" tall, a single sender is used. The sender ends should be 1/4" to 3/4" away from the top and bottom of the tank, to allow for the thickness of the tank top and bottom and any bows in them (see the diagrams). The senders are calibrated to account for this distance from the bottom of the tank. The sender is cut to the nearest even 1.5 inch in length, for example, a system with a tank height of 11.75 inches, cut the sender to be 10.5 inches long, this allows 5/8" at each end when the sender is centered vertically on the tank. **IMPORTANT: Do not cut the sender shorter than 4-1/2 inches! The sender will not work if it is cut less than 4-1/2 inches.**
7. For tanks greater than 13" tall, two stacked senders are used. This is only possible for the fresh and black tanks. The sender ends should be 1/4" to 3/4" away from the top and bottom of the tank, to allow for the thickness of the tank top and bottom and any bows in them (see the diagrams). The senders are calibrated to account for this distance from the bottom of the tank. In addition, there needs to be a gap of 1/16" to 1/8" to between the two senders. Therefore total length of both senders will be: tank height -1/4"-1/4"-1/8", then rounded down to the nearest 1.5 inches. The top and bottom senders should be approximately the same length for best results. For example, if the tank height is 22", then 22"-1/4"-1/4"-1/8"=21 3/8", so the total length of both senders will be 21 inches. Make both senders 10.5" long.

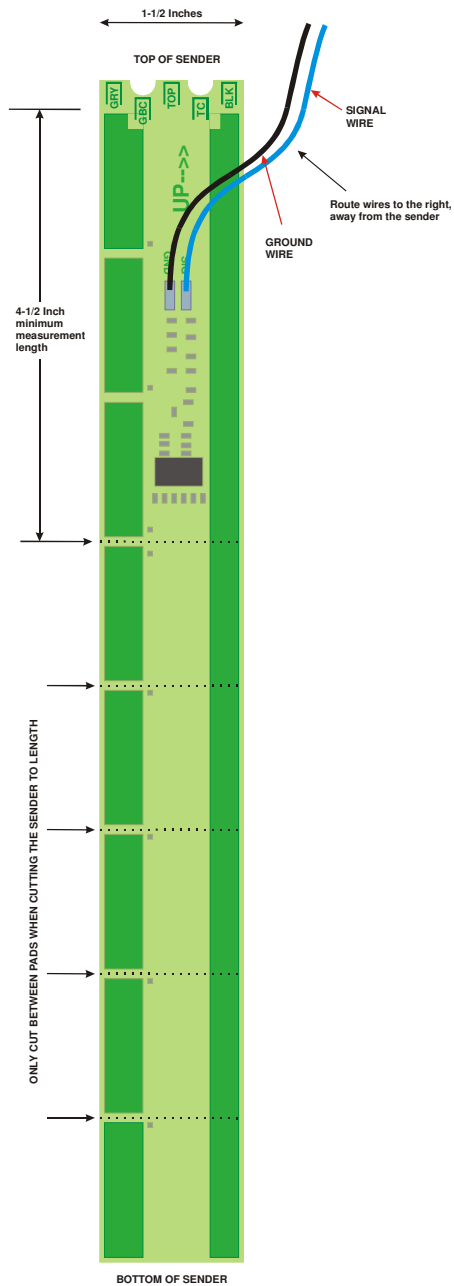

8. To make the senders the right length (assuming they are too long) they will need to cut off with a pair of scissors. The end to be cut is the bottom end, which is the opposite end from the top where the wires come out (see the diagrams). DO NOT cut the sides, and DO NOT cut the sender shorter than 4-1/2 inches. The cut must be in between the sensor pads, and the cut must be made parallel to the existing bottom end. Double check your measurements, if the sender is cut too short, it cannot be lengthened.
9. The senders need to be programmed so they know which tank they are on. This is done by selectively cutting off the tabs on the top of the sender. See the chapter entitled "**SENDER PROGRAMMING**" and the section "**To program the sender for the correct tank**" for details.
10. For two stacked sender systems, the senders need to be programmed so they know that they are being used as top or bottom senders. See the chapter entitled "**SENDER PROGRAMMING**" and the section "**To program the sender as top or bottom**" for details.
11. Once the sender is cut to length and programmed, carefully peel the backing paper off the adhesive. Do this slowly to prevent the adhesive from being ripped off the sender, and to prevent the backing paper from ripping. Be careful not to bend the sender sharply in the process. Position the sender over the side of the tank and carefully stick it down. MAKE SURE THAT THE END

WITH WIRES IS POINTING UP!! Position the bottom of the sender at least 1/4" above the bottom of the tank, and more if required to equalize the space at the top and bottom of the tank. Make sure that the sender is square with the tank. You only have one shot at this, if you try to peel it off the tank once it is stuck the sender may be damaged by the sharp bending. Carefully press the sender down to the tank so that all of the adhesive is contacting the tank wall.

12. Connect the all the blue wires from the senders together, and to the blue wire from the display. Connect the black wire from each sender to ground. Use Marrette or crimp connectors to fasten the wires together. Make sure that the wires from the sender are routed away from the sender, if they drape over the sender they could affect the reading. Secure the wires with tie wraps or something similar so that the wires do not rattle or press against the sender, this may result in sender damage or wires breaking over time.
13. Do steps 4 to 12 for the other two holding tanks.
14. All that remains now is calibration and testing. The tank senders will self calibrate to whatever length they are cut, so they will always read from 0 to 100%. The display needs to be set to a one or two sender system for each tank. See the chapter entitled "**DISPLAY CALIBRATION**" and the section "***To calibrate the number of senders for each tank***" for details. Make sure you do it for each tank.
15. For the initial test, have the tank at least 1/4 full of water or sewage, and verify that the percent level reading looks correct (see the chapter entitled "**OPERATING INSTRUCTIONS**" and the section "***To read a water or sewer tank level***" for details). Check to see that the signal power is at least 12% (see the chapter entitled "**TROUBLESHOOTING GUIDE**" and the section "***To review the sender diagnostics***" for details). If the signal power is too low, make sure that the sender(s) is well stuck to the side of the tank and that the tank is reasonably clean inside, as a large buildup will reduce signal strength. The gauge will work with maximum signal strengths as low as 5%, but it is good to have at least 12% at installation so that there is some margin available for buildup in the tank. Note that the system "learns" about the characteristics of the tank with use, so the readings may be inaccurate when the tank is empty or almost empty when the system is first tested. Once the tank has been filled at least 1/4 full the system will be properly "taught" and should read correctly after that.
16. Connect the pump and heater switches as required.
WARNING: The pump and heater switches are rated for a maximum of 6 amps. The use of a relay is required if more than 6 amps is needed.
17. Verify that the battery voltage reads correctly. If it appears low, make sure you have good wiring for the 12 volt power and the ground.

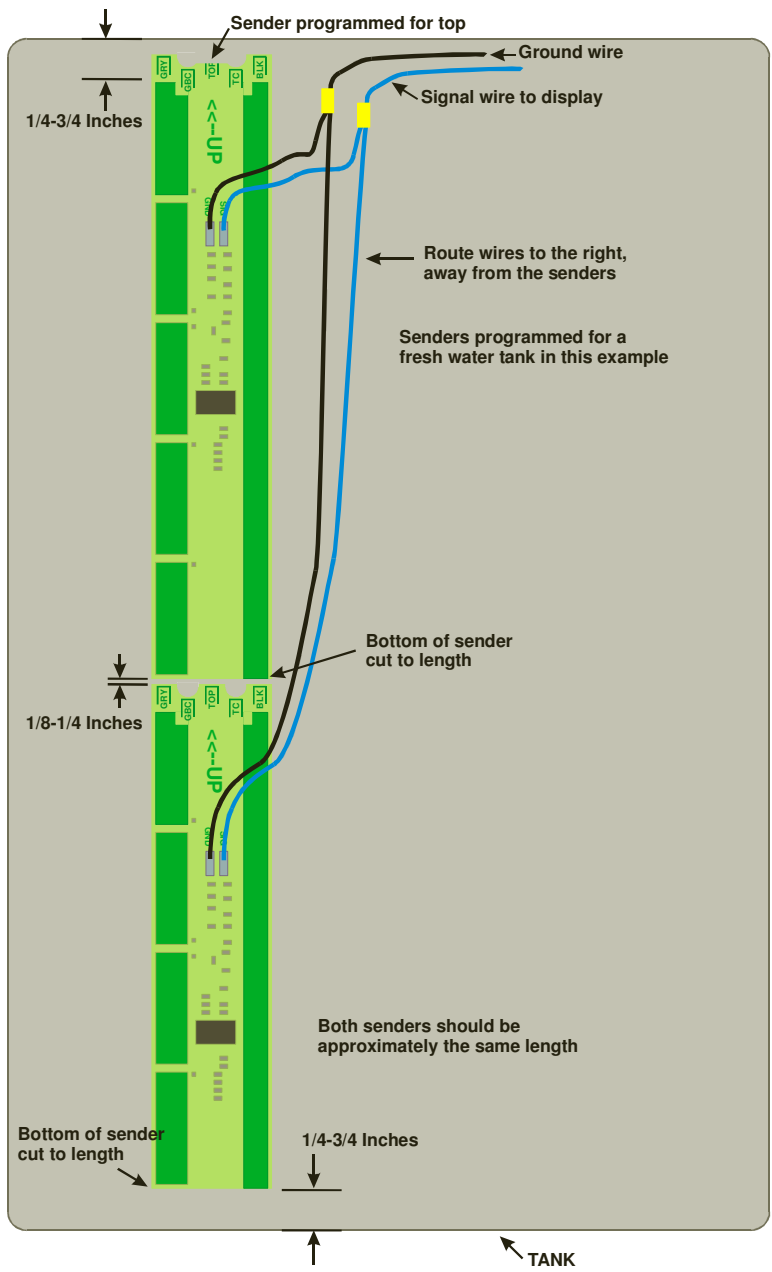

Typical Dual Stacked Sender Installation

CHAPTER 7 TROUBLESHOOTING GUIDE

Display trouble codes:

If a sender or its wiring is not operating properly, the following codes are shown on the display:

1. If a sender is unresponsive or there is an open circuit in the wiring so that the sender is not connected, the display will indicate an open circuit by showing "OPn" on the LED display.
2. If a sender is shorted or there is a short in the wiring, the display will indicate a short circuit by showing "Sht" on the LED display.
3. If a sender is sending bad data, there is damaged wiring, or if there is electrical interference, the display will indicate a data error by showing "Err" on the LED display. Also, if the senders have not been programmed correctly, they can interfere with one another and result in "Err" on the LED display. Check all the senders to make sure they are programmed correctly. If they are, replace the sender that is creating the error.
4. If the display has been programmed for a single sender, and dual stacked senders have been connected, the display will show "StA". In this case, change the senders or reprogram the display as required. If only a top sender has been connected, the display will show "nbo", indicating that no bottom sender has been received. If the tank should only have 1 sender, correct the programming on the sender, it should not be a top sender.
5. If the display has been programmed for dual stacked senders for tall tanks, and only the bottom sender is working and the top one is not, then the display will show "ntP" indicating that no top sender is being received. If the top is working but no bottom sender is being received, then the display will show "nbo". If neither sender is working, then the display will show "OPn". Check the wiring and the programming of the senders. If all is OK with that, replace the bad sender.
6. The display contains a permanent memory which is used to store the programming for battery voltage calibration value, the LPG calibration value, and the tank sender signal levels. These signal levels are used to help the system adapt to the tanks, which increases sender accuracy at low tank levels. If this memory should fail, "CAL" will be flashed on the LED display, indicating a calibration failure. It will be necessary to replace the display if this occurs.
7. The diagnostics can be used to check the wiring and the senders:
 - a. If a short circuit is showing, disconnect the senders one at a time at the sender location. If the short circuit indication goes away when a sender is removed, then that sender is bad. If all the senders are removed but a short circuit still shows, then the wiring may be shorted. Disconnect the sender wire at the display, the short indication should go away. If it doesn't, the display is bad.
 - b. If an open circuit for all the senders is showing, it is most likely a wiring open circuit or display failure, since it is unlikely that all three senders are bad. Try shorting the wiring together at the display, the display should indicate a short circuit. If it doesn't, the display is bad. If it does, then remove that connection and short the wires together at the sender locations. If no short circuit is shown, then the wiring is open. If the display does show a short circuit, then the senders must be bad.
 - c. If a single sender is showing an open, try shorting the wiring together right at that sender. If a short now shows, the sender is bad or not wired properly. If no short circuit shows on the display, the wiring to that sender is open.

To review the sender diagnostics:

1. The sender diagnostics can be reviewed periodically to check for any degradation of the tank senders. If a sender appears to be malfunctioning, reviewing the diagnostics should be the first

step in the troubleshooting process. Note that there are no diagnostics for the battery voltage or LPG.

2. There are two diagnostics for the senders: the signal power, and the sender height.
 - a. The signal power is an indication of how much signal is being transmitted through the tank wall and picked up by the receive part of the sender. If the signal power is too low, it can indicate a sender which is detached from the tank, excessive buildup on the inside of the tank, bad wiring to the sender, low battery voltage, or a defective sender. The minimum signal power for proper operation is 5%.
 - b. The sender height is the number of receive segments present in the sender. To determine the length of the sender, multiply the calibration by 1.5 to get the length in inches. The senders always auto calibrate to the length that they are cut, so this diagnostic allows the user to confirm the length and to make sure that the auto calibration is working properly.
3. To check the diagnostics, press and hold the button for the tank to be checked, the display will show the level for that tank.
4. While continuing to hold down the button for the tank, press the BATT button. When the display shows "dIA", release the buttons, the display will then change to showing the signal power diagnostic. This is indicated by a "P" showing on the left digit, for example "P26" indicates a 26% signal power.
5. The signal power will show for 5 seconds. The display will then change to showing the sender height. This is indicated by a small "h" showing on the left digit, for example "h 6" indicates that the sender has 6 receive segments, which is 9 inches high.
6. After 5 seconds of showing the height, the display will shut off.

CHAPTER 8 SERVICE AND WARRANTY INFORMATION

The warranty will apply only if the warranty card shipped with the equipment has been returned to Garnet Technologies Inc.

Garnet Technologies Inc. warrants equipment manufactured by Garnet to be free from defects in material and workmanship under normal use and service for a period of one year from the date of sale from Garnet or an Authorized Dealer. The warranty period will start from the date of purchase or installation as indicated on the warranty card. Under these warranties, Garnet shall be responsible only for actual loss or damage suffered and then only to the extent of Garnet's invoiced price of the product. Garnet shall not be liable in any case for labor charges for indirect, special, or consequential damages. Garnet shall not be liable in any case for the removal and/or reinstallation of defective Garnet equipment. These warranties shall not apply to any defects or other damages to any Garnet equipment that has been altered or tampered with by anyone other than Garnet factory representatives. In all cases, Garnet will warrant only Garnet products which are being used for applications acceptable to Garnet and within the technical specifications of the particular product. In addition, Garnet will warrant only those products which have been installed and maintained according to Garnet factory specifications.

LIMITATION ON WARRANTIES

These warranties are the only warranties, expressed or implied, upon which products are sold by Garnet and Garnet makes no warranty of merchantability or fitness for any particular purpose in respect to the products sold. Garnet products or parts thereof assumed to be defective by the purchaser within the stipulated warranty period should be returned to the seller, local distributor, or directly to Garnet for evaluation and service. Whenever direct factory evaluation, service or replacement is necessary, the customer must first, by either letter or phone, obtain a Returned Material Authorization (RMA) from Garnet Technologies directly. No material may be returned to Garnet without an RMA number assigned to it or without proper factory authorization. Any returns must be returned freight prepaid to: Garnet Technologies Inc., Suite 8, 125 M&M Ranch Road, Granbury, Texas, 76049. Returned warranted items will be repaired or replaced at the discretion of Garnet Instruments. Any Garnet items under the Garnet Warranty Policy that are deemed irreparable by Garnet Technologies will be replaced at no charge or a credit will be issued for that item subject to the customer's request.

If you do have a warranty claim or if the equipment needs to be serviced, contact the installation dealer. If you do need to contact Garnet, we can be reached as follows:

Garnet Technologies Inc.
Suite 8, 125 M&M Ranch Road
Granbury, Texas, 76049
Email: sales@rvgauge.com

CHAPTER 9 SPECIFICATIONS

Resolution:	3/8 inch (10 mm)
Accuracy:	+/- 8% or better, limited by resolution and tank height and shape
Temperature range:	+32 to +140°F (0 to + 60°C)
Sender materials:	0.008" thick glass epoxy circuit board with conformal coating for circuit protection. Laminated on the back with 3M 300LSE Bonding Adhesive.
Sender length range:	4-1/2 to 12 inches, which will measure tank heights from 5" to 14" (single sender) and up to 26" (dual senders).
Display mounting panel:	Black panel, approximately 4" wide by 2.8" high by 1" thick (102mm wide X 71mm high X 25mm deep). Panel screws to wall.
Power requirements:	Display requires 12 volts from the RV battery, the system will function from 11 volts to 16 volts. Current drain is less than 200mA.
Pump switches:	The pump switch is rated for a maximum of 6 amps. A relay is required if more than 6 amps is needed.
Wiring:	A single two wire conductor required from the display to the senders. All the senders are wired in parallel. 12 V power and ground required for display. Single wire required for LPG sender if sender grounded at tank.

